

S15

Speicherstein



Abbildung: S15 (Grundmodell)
Oberflächenveredelung:
Camina Sichtbetonoptik

Abbildung: S15 in Kombination mit Designbeton
Oberflächenveredelung: Camina Sichtbetonoptik



Standard



Tür
hochschiebbar



Front
Anthrazit

Gesamtgewicht



ca.
615 kg

Kamineinsatz

Ekko U 55(45)51 h
NW-Leistung: 9 kW
Abgasstutzen: Ø 200 mm



A

Mehr Infos unter
camina-schmid.de

Optional



Front veredelt



Front veredelt
(komplett)

Zubehör



SMR



Vorlegeplatte

Speicherbeton



Speicherbeton



Designbeton

Frontansicht M 1:20

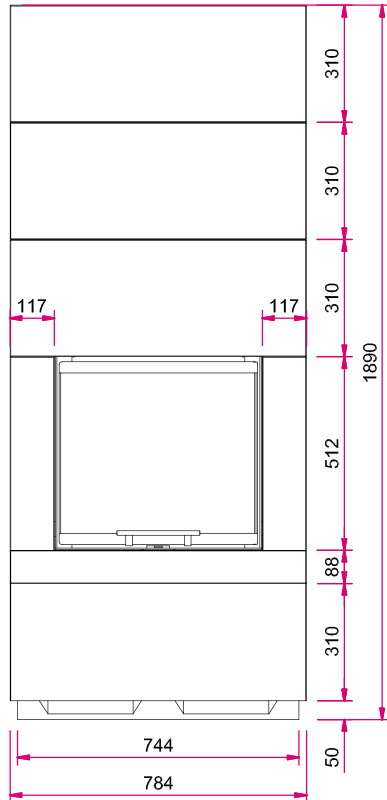

Seitenansicht links M 1:20

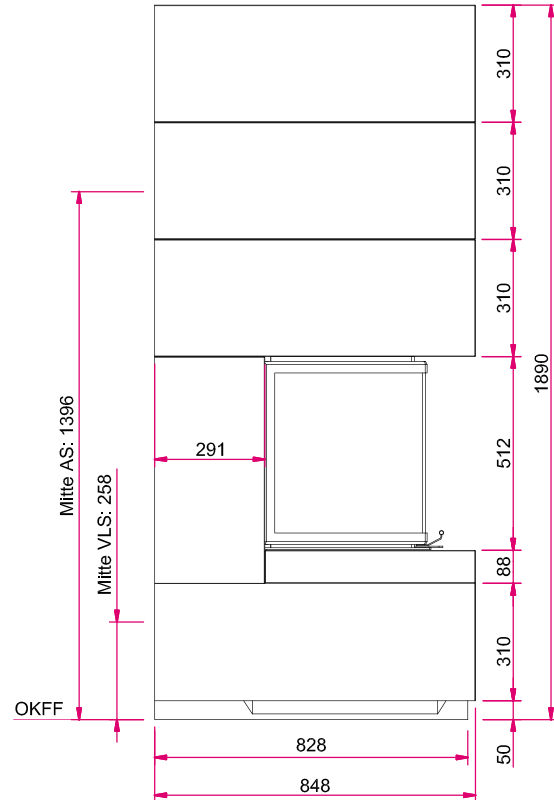

Hinweis: Mit **optionalem Zubehör** bitte die Angaben in den Preislisten beachten.
AS: Abgasstutzen, VLS: Verbrennungsluftstutzen, OKFF: Oberkante Fertigfußboden

Draufsicht M 1:20

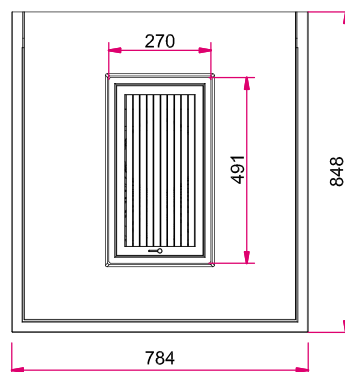

S15 mit Naturstein-Bank (mit Überstand) Speicherstein



Abbildung: S15 (Grundmodell)
Oberflächenveredelung:
Camina Sichtbetonoptik

Abbildung: S15 mit Naturstein-Bank Grigio (mit Überstand)
Oberflächenveredelung: Camina Sichtbetonoptik



Standard



Gesamtgewicht



Kamineinsatz

Ekko U 55(45)51 h
NW-Leistung: 9 kW
Abgasstutzen: Ø 200 mm



Mehr Infos unter
camina-schmid.de

Optional



Zubehör



Naturstein und Speicherbeton

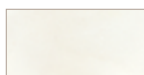

Maßzeichnungen S15 mit Naturstein-Bank (mit Überstand)

Frontansicht M 1:20

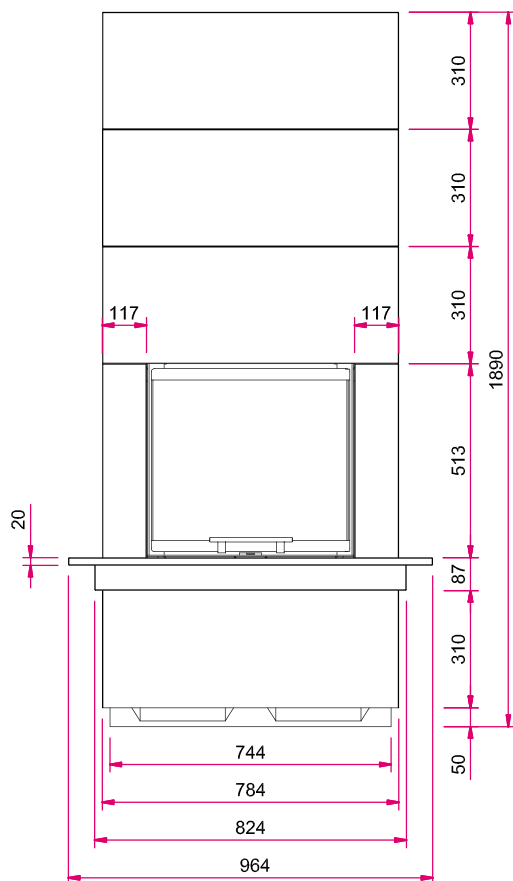

Seitenansicht links M 1:20

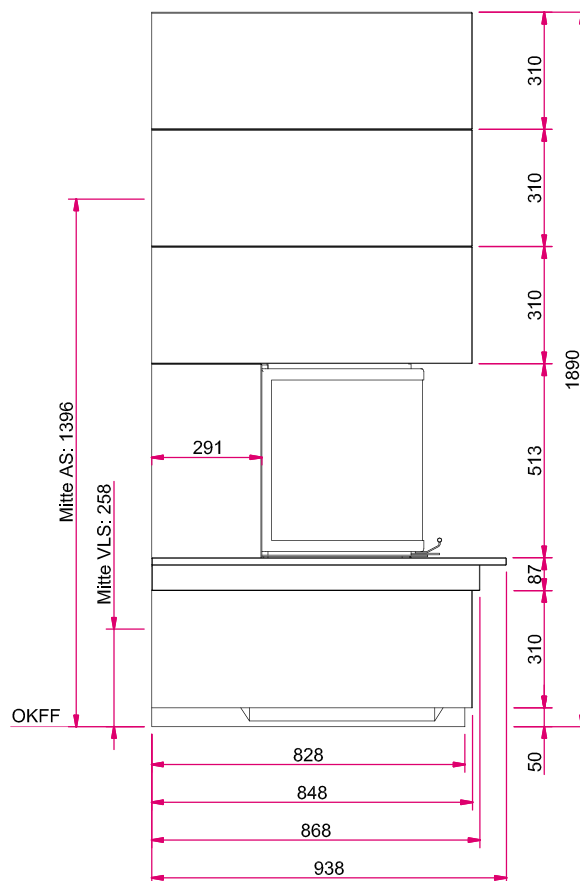

Hinweis: Mit **optionalem Zubehör** bitte die Angaben in den Preislisten beachten.
AS: Abgasstutzen, VLS: Verbrennungsluftstutzen, OKFF: Oberkante Fertigfußboden

Draufsicht M 1:20

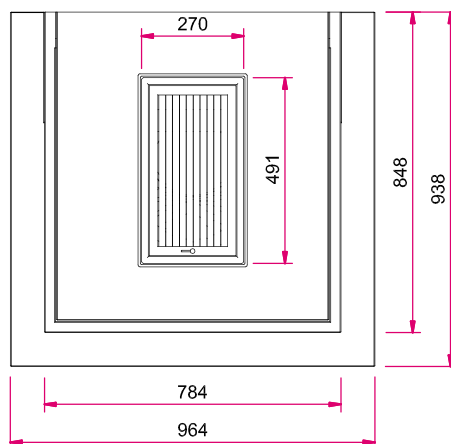

S15 mit Naturstein-Feuertisch Speicherstein



Abbildung: S15 mit Naturstein-Feuertisch Nero
Oberflächenveredelung: Camina Silikatanstrich



Standard



Tür
hochschiebbar



Front
Anthrazit

Gesamtgewicht



kg
ca.
625 kg

Kamineinsatz

Ekko U 55(45)51 h
NW-Leistung: 9 kW
Abgasstutzen: Ø 200 mm



A

Mehr Infos unter
camina-schmid.de

Optional



Front veredelt



Front veredelt
(komplett)

Zubehör



SMR



Vorlegeplatte

Naturstein und Speicherbeton

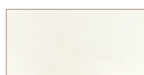

Estremos



Grigio



Jade



Marone



Mocca Creme



Nero



Nero matt



Sabbia



Speicherbeton

Maßzeichnungen S15 mit Naturstein-Feuertisch

Frontansicht M 1:20

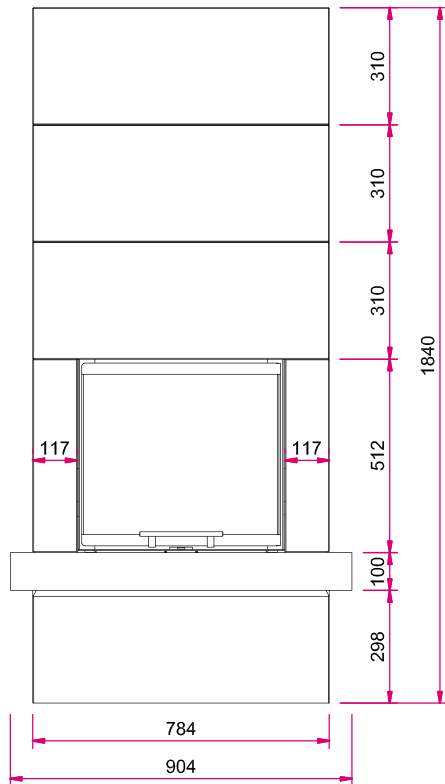

Seitenansicht links M 1:20

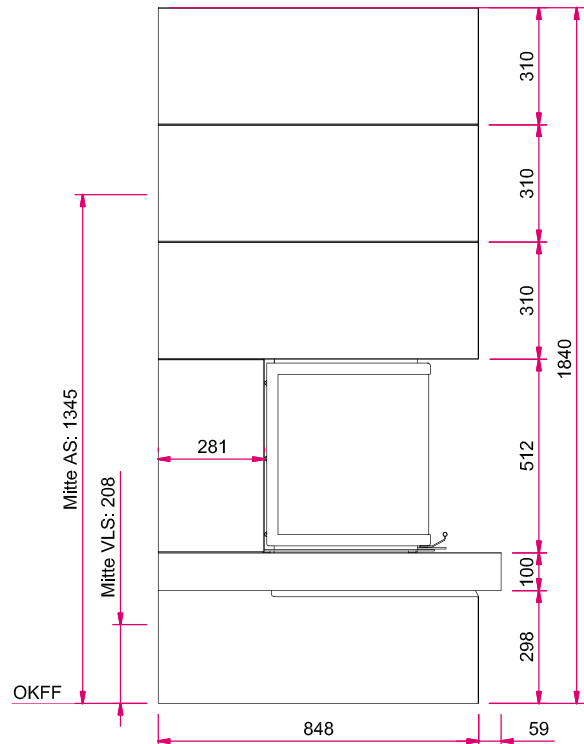

Hinweis: Mit optionalem Zubehör bitte die Angaben in den Preislisten beachten.
AS: Abgasstutzen, VLS: Verbrennungsluftstutzen, OKFF: Oberkante Fertigfußboden

Draufsicht M 1:20

