

# S9 Hoch

## Speicherstein



Abbildung: S9 Hoch (Grundmodell)  
Oberflächenveredelung:  
Camina Sichtbetonoptik



Abbildung: S9 Hoch in Kombination  
mit Naturstein-Bank Nero matt (ohne  
Überstand)  
Oberflächenveredelung:  
Camina Sichtbetonoptik

Abbildung: S9 Hoch in Kombination mit Designbeton  
Oberflächenveredelung: Camina Silikatanstrich



### Standard



### Gesamtgewicht

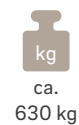

### Kamineinsatz

Ekko 45(45)57 s  
NW-Leistung: 7 kW  
Abgasutzen: Ø 180 mm

### Optional



Mehr Infos unter  
[camina-schmid.de](http://camina-schmid.de)

### Zubehör



### Naturstein und Speicherbeton

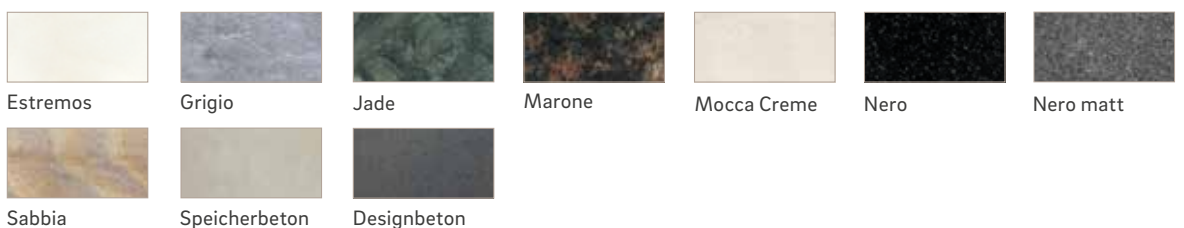

## Frontansicht M 1:20

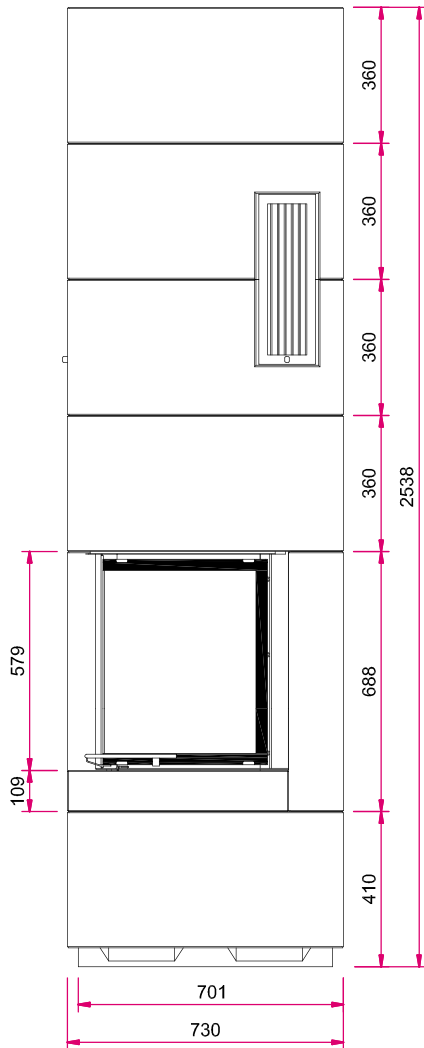

## Seitenansicht links M 1:20

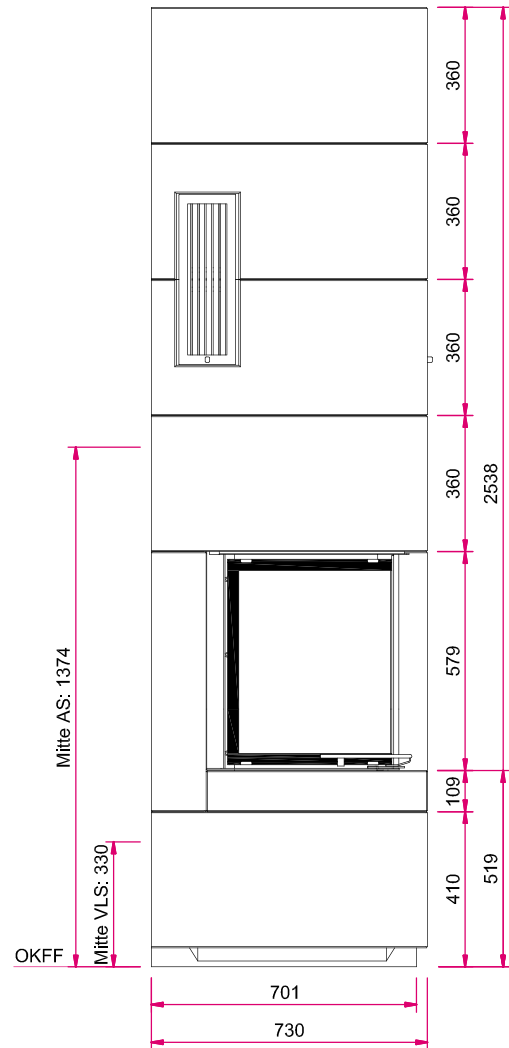

Hinweis: Mit optionalem Zubehör bitte die Angaben in den Preislisten beachten.  
AS: Abgasutzen, VLS: Verbrennungsluftutzen, OKFF: Oberkante Fertigfußboden

## Draufsicht M 1:20

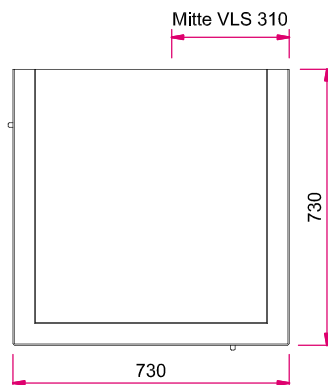

# S9 Hoch mit Naturstein-Bank (mit Überstand) Speicherstein



Abbildung: S9 Hoch (Grundmodell)  
Oberflächenveredelung:  
Camina Sichtbetonoptik

Abbildung: S9 Hoch in Kombination mit Naturstein-Bank Grigio (mit Überstand)  
Oberflächenveredelung: Camina Sichtbetonoptik



## Standard



## Gesamtgewicht

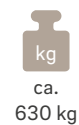

## Kamineinsatz

Ekko 45(45)57 s  
NW-Leistung: 7 kW  
Abgasstutzen: Ø 180 mm

## Optional



Mehr Infos unter  
[camina-schmid.de](http://camina-schmid.de)

## Zubehör



## Naturstein und Speicherbeton

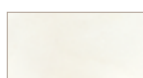

# Maßzeichnungen S9 Hoch mit Naturstein-Bank (mit Überstand)

Frontansicht M 1:20

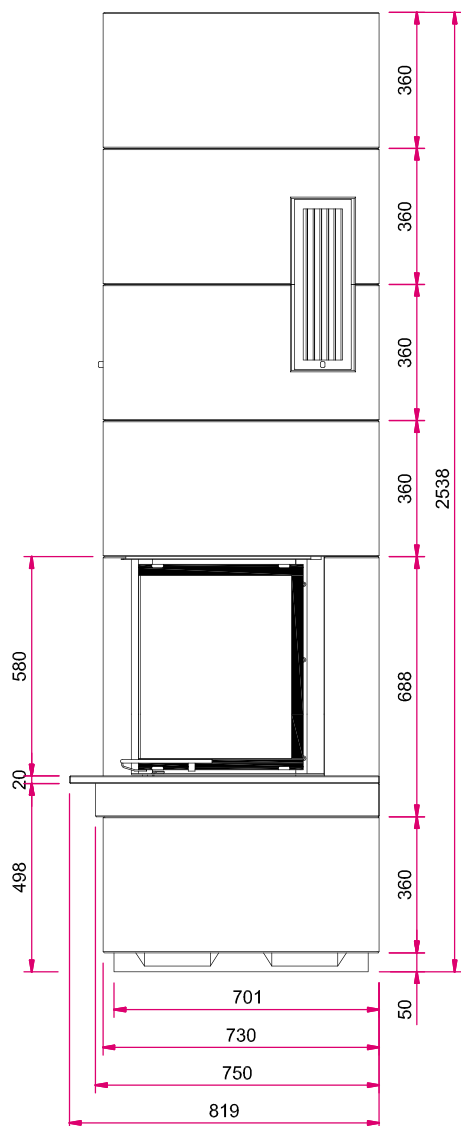

Seitenansicht links M 1:20

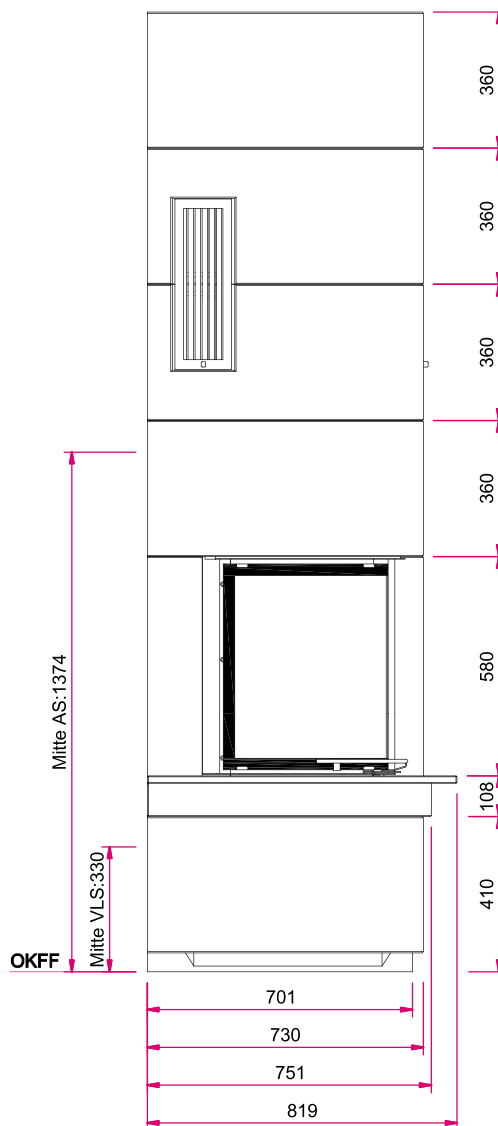

Hinweis: Mit optionalem Zubehör bitte die Angaben in den Preislisten beachten.  
AS: Abgasutzen, VLS: Verbrennungsluftutzen, OKFF: Oberkante Fertigfußboden

Draufsicht M 1:20

